



ELKIM

lighting

Portfolio
2022/2023

ELKIM

lighting

Portfolio 2022/2023

Każde wydarzenie branżowe - targi, pokaz, szkolenie są dla nas impulsem do wprowadzenia nowych produktów, zaprezentowania się z jak najlepszej strony. Pobudzają naszą wyobraźnię, motywują do wzmożonej pracy, zwiększają kreatywność oraz podnoszą morale.

Nigdy nie możemy zaprezentować wszystkich naszych lamp - jest to niemożliwe ze względu na ilość produktów i ich wariantów, ponieważ stworzyłyby to chaos, zabrało przejrzystość.

Tym razem chcemy pokazać nasze nowości i niektóre znane oprawy oświetleniowe w nowych odstonach, kolorach, barwach światła, czy też nieoczywistych aranżacjach.

Za pomoc dziękujemy wszystkim naszym Przyjaciołom, których projekty mamy zaszczyt zaprezentować w niniejszym folderze.

Zapraszamy do zapoznania się z naszymi propozycjami.

Zespół Elkim Lighting

Spis treści



str. 4



str. 5



str. 5



str. 6



str. 7



str. 7



str. 7



str. 8



str. 8



str. 9



str. 9



str. 9



str. 10



str. 10



str. 11



str. 12



str. 13



str. 14



str. 15



str. 16



str. 16



str. 17



str. 18



str. 19



str. 19



str. 20



str. 20



str. 21



str. 21



str. 22



str. 23



str. 24



str. 25

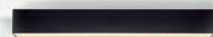

str. 26



str. 27



str. 27



str. 27



str. 28



str. 28



str. 29



str. 29



str. 30



str. 30



str. 30



str. 31

WAND 466



| | |
|----------------|---------|
| Źródło światła | SMD LED |
| Moc | 6W |
| Strumień | 500lm |
| Barwa światła | 3000K |
| Kąt świecenia | 120° |

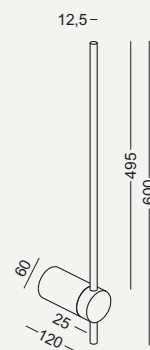
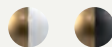

ELKIM
lighting

WAND 467 i 467A

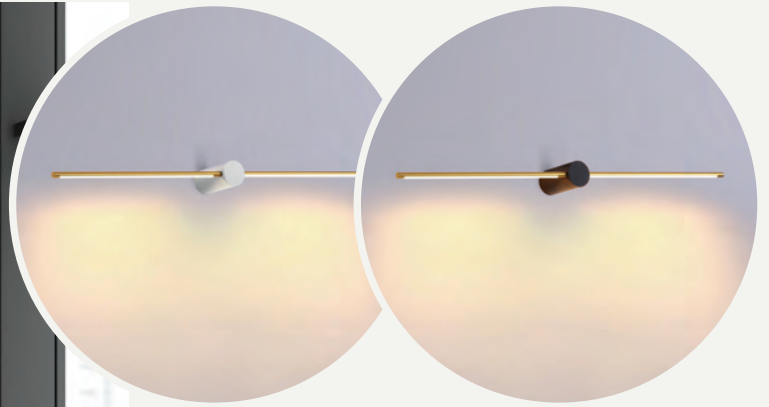

| | |
|----------------|---------|
| Źródło światła | SMD LED |
| Moc | 10W |
| Strumień | 850lm |
| Barwa światła | 3000K |
| Kąt świecenia | 120° |

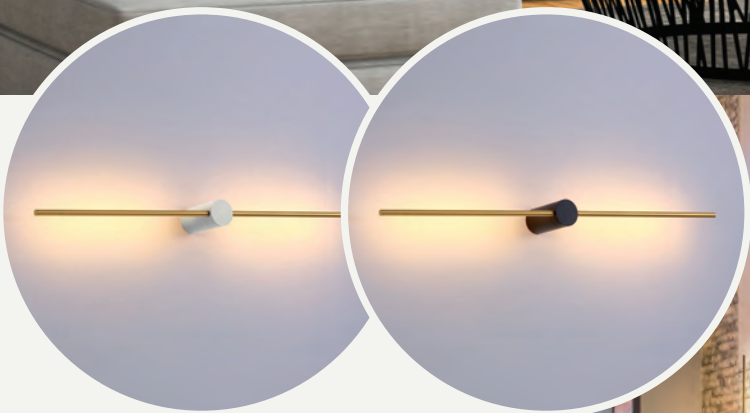

WAND 467A

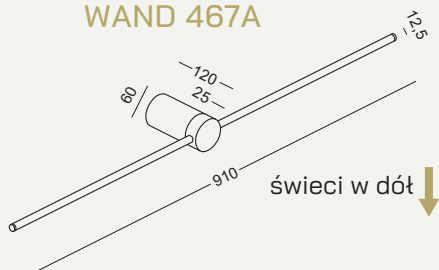

WAND 467

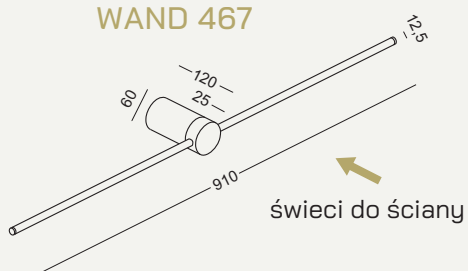

WAND 469

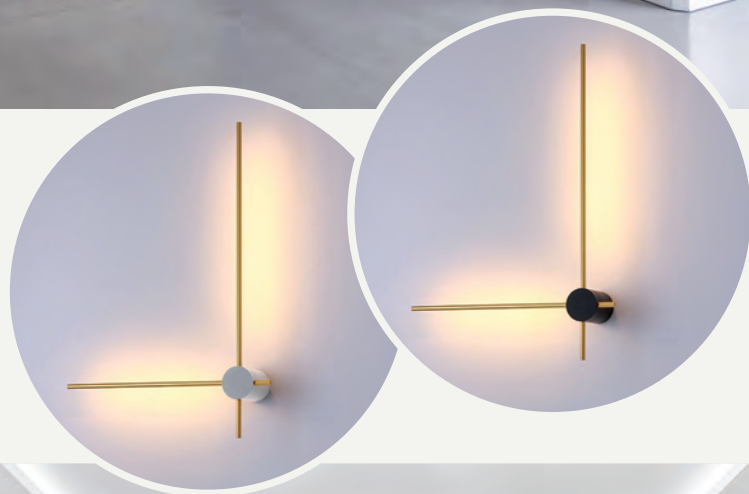

| | |
|----------------|---------|
| Źródło światła | SMD LED |
| Moc | 12W |
| Strumień | 1000lm |
| Barwa światła | 3000K |
| Kąt świecenia | 120° |

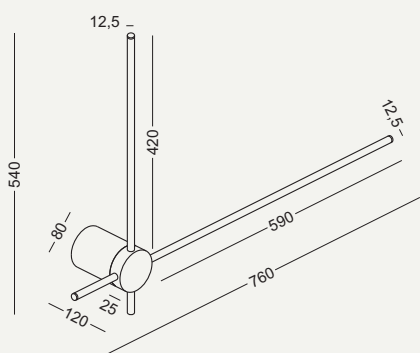
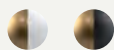

LINE 243, 243A, 473

| | |
|----------------|--------------|
| Źródło światła | SMD LED |
| Moc | 10W |
| Strumień | 600-620lm |
| Barwa światła | 3000K, 4000K |
| Kąt świecenia | 120° |

Lampa ścienna z możliwością obracania

LINE 243A

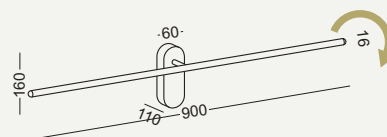

LINE 243

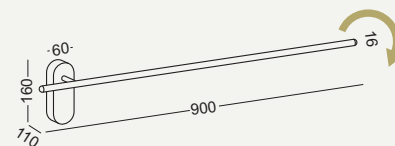

LINE 473

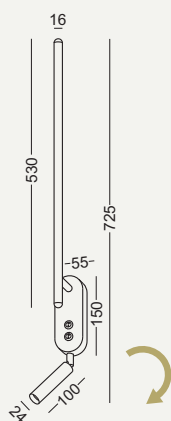

| | |
|----------------|---------------|
| Źródło światła | SMD LED |
| Moc | 6W + 3W |
| Strumień | 360lm + 160lm |
| Barwa światła | 3000K |
| Kąt świecenia | 120° + 30° |

Dwa niezależne źródła światła z osobnymi włącznikami.



BUKET 394 i 395

BUKET 394

| | |
|----------------|---------|
| Źródło światła | SMD LED |
| Moc | 2W |
| Strumień | 200lm |
| Barwa światła | 3000K |
| Kąt świecenia | 110° |

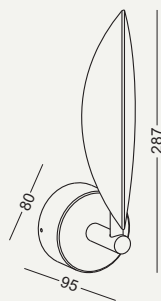

BUKET 395

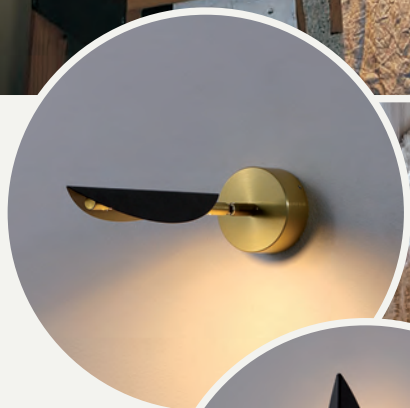
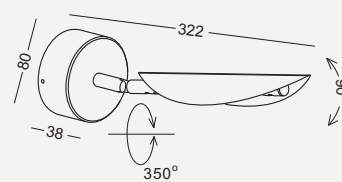

ELKIM

Lighting



| | |
|----------------|---------------------|
| Źródło światła | Power LED + SMD LED |
| Moc | 3W + 4W |
| Strumień | 160lm + 400lm |
| Barwa światła | 3000K |
| Kąt świecenia | 30° + 360° |



Posiada dwa niezależne źródła światła z osobnymi włącznikami.

HOTELS 417H

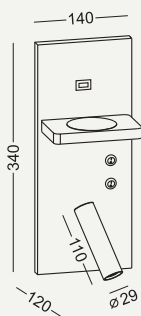

HOTELS 417L

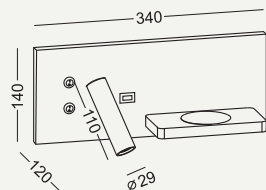

HOTELS 417P

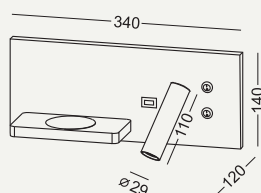

Ruchomy reflektorek pozwalający na skierowanie źródła światła w dowolnym kierunku.



SULTA 220 i 423



Lampa na giętkim pałąku pozwala na skierowanie strumienia światła w dowolnym kierunku.

| | |
|----------------|---------------------|
| Źródło światła | Power LED |
| Moc | 3W |
| Strumień | 160lm - 221lm |
| Barwa światła | 3000K, 4000K, 6000K |
| Kąt świecenia | 30°, 60° |

SULTA 423

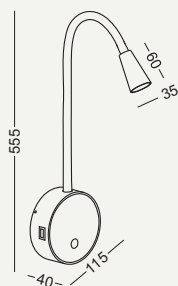

SULTA 220

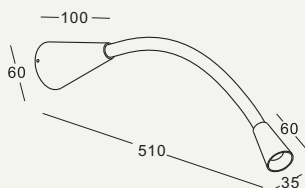

ELKIM
lighting

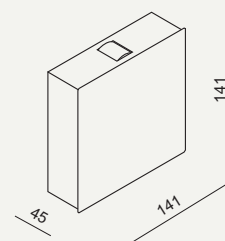
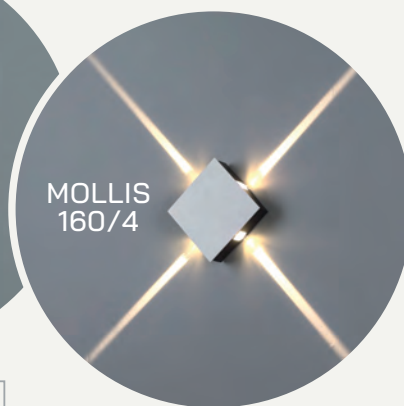
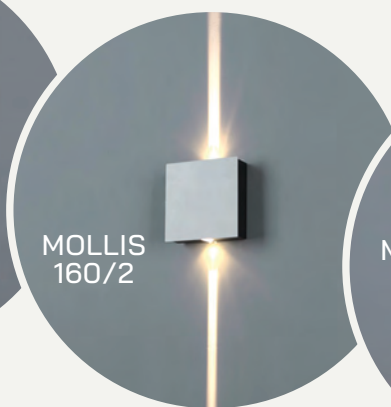
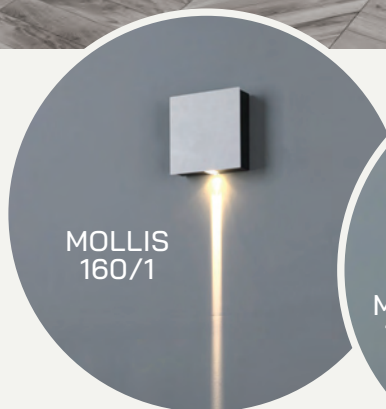

| | |
|----------------|-----------------------|
| Źródło światła | Power LED |
| Moc | 1x1W, 2x1W, 4x1W |
| Strumień | 94lm - 130lm / strona |
| Barwa światła | 3000K, 4000K, 6000K |
| Kąt świecenia | 25°x5° |

Lampa o zasięgu strumienia świetlnego ok 4m.
Prześtona 25°x5°

Do lampy można domówić prześtonę 80°



LINE 363



| | |
|----------------|---------|
| Źródło światła | SMD LED |
| Moc | 18W |
| Strumień | 1800lm |
| Barwa światła | 3000K |
| Kąt świecenia | 110° |

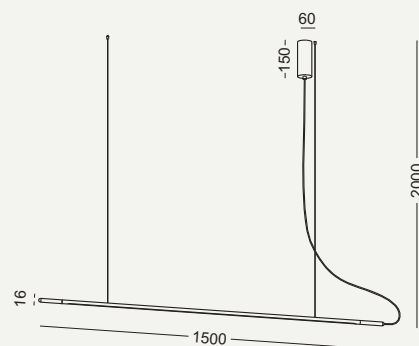

ELKIM
lighting

BUKET 357

| | |
|----------------|---------|
| Źródło światła | SMD LED |
| Moc | 14W |
| Strumień | 1400lm |
| Barwa światła | 3000K |
| Kąt świecenia | 110° |

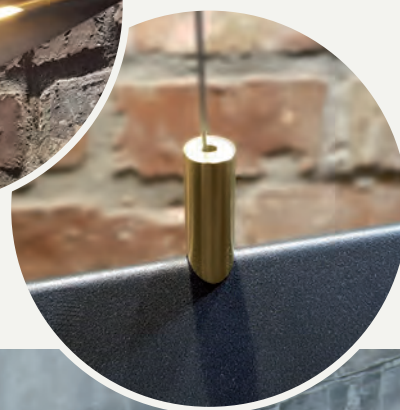
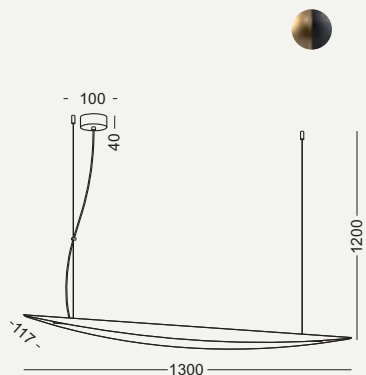

LUPINUS

zwieszany

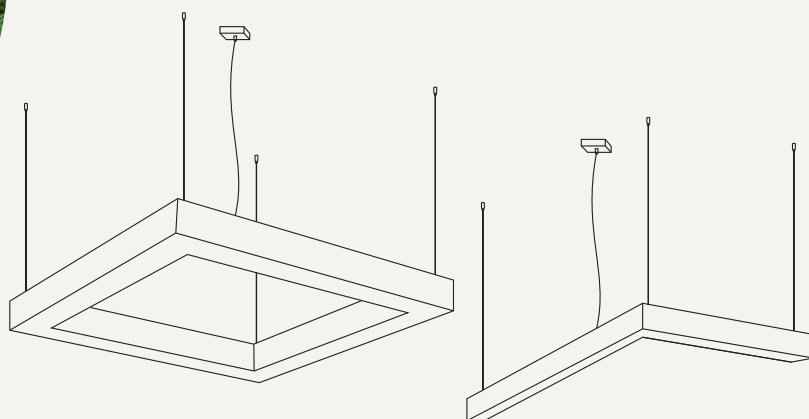

| | |
|----------------|-----------------------------------|
| Źródło światła | SMD LED |
| Moc | 13,8W/mb (SP) lub 27,6W/mb (DP) |
| Strumień | 1610lm/mb (SP) lub 3900lm/mb (DP) |
| Barwa światła | 3000K, 4000K |
| Kąt świecenia | 90° (HQ), 100° (SQ) |

Standardowo stosowana jest przestona SOFT OPAL. Na zamówienie stosujemy typ: OPAL lub mikropryzma.

Do tych lamp montujemy również systemy ściemniania: Switch Dim, DALI, CASAMBI.



ELKIM
lighting

LUPINUS

zwieszany

| | |
|----------------|-----------------------------------|
| Źródło światła | SMD LED |
| Moc | 13,8W/mb (SP) lub 27,6W/mb (DP) |
| Strumień | 1610lm/mb (SP) lub 3900lm/mb (DP) |
| Barwa światła | 3000K, 4000K |
| Kąt świecenia | 90° (HQ), 100° (SQ) |

Lampy wiszące LUPINUS wykonujemy w oparciu o profile długości L-3000 mm, dlatego taki profil, poprzez jego łączenie, ma nieograniczone możliwości pod względem maksymalnej długości.

Rozmieszczenie linek zwieszających czy inne typy podstaw sufitowych można ustalić indywidualnie.

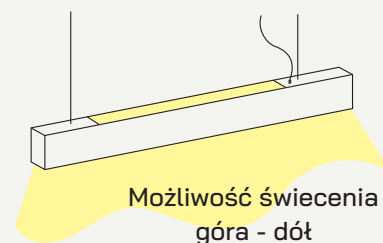
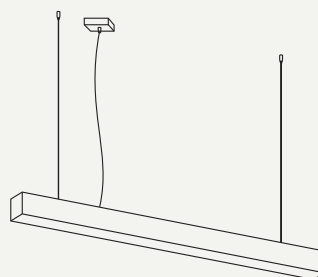
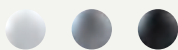

SCOP 012 i 012 SLIM

Dla lamp SCOP istnieje możliwość wykonania podstaw zbiorczych o dowolnych rozmiarach. Delikatna linka jest jednocześnie przewodem zasilającym.



SCOP 012



SCOP 012 SLIM

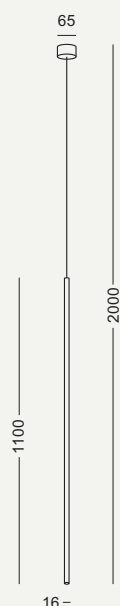

SCOP 012 SCOP 012 SLIM

| Źródło światła | Power LED | |
|----------------|---------------------|--------------|
| Moc | 3W | 1W |
| Strumień | 160lm - 221lm | 94lm - 120lm |
| Barwa światła | 3000K, 4000K, 6000K | |
| Kąt świecenia | 30°, 60° | 30° |

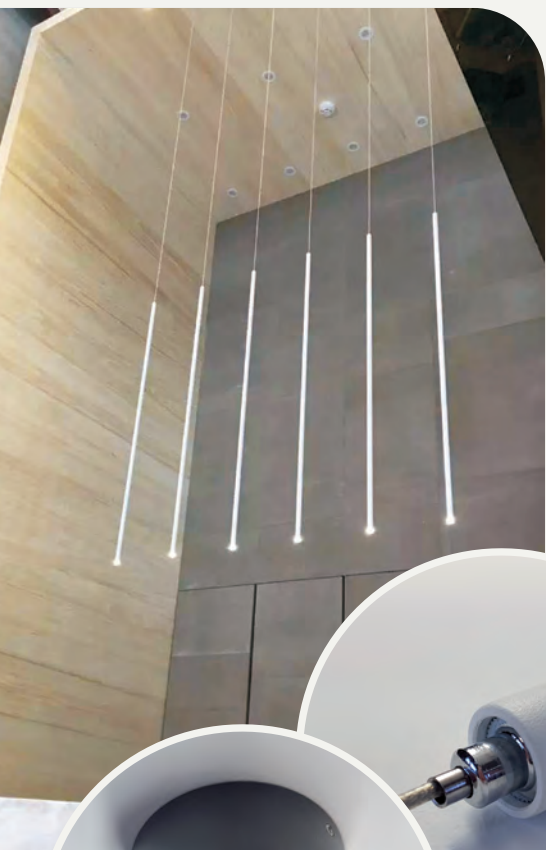

Lampy SLIMA wykonujemy w oparciu o profile długości do L-2000 mm. Dostępne są wersje w liniach prostych, kwadratach, prostokątach oraz innych kształtach.

| | |
|----------------|--------------|
| Źródło światła | SMD LED |
| Moc | 18W/mb |
| Strumień | 1400lm/mb |
| Barwa światła | 3000K, 4000K |
| Kąt świecenia | 100° |



Typ A.

Typ B.

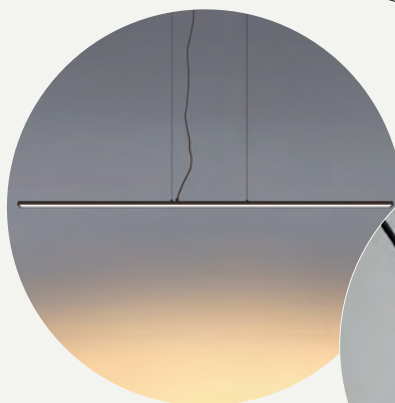
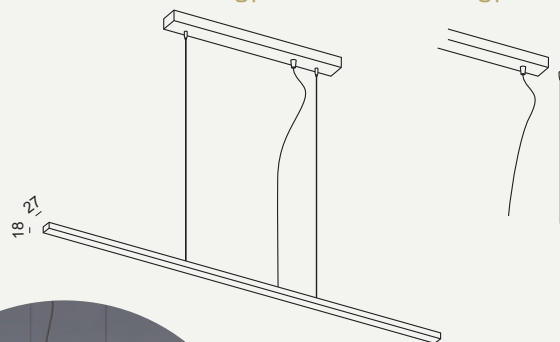

LUPINUS WPUST



Lampy wpuszczane LUPINUS wykonujemy w oparciu o profile długości L-3000 mm, dlatego taki profil poprzez jego łączenie ma nieograniczone możliwości pod względem maksymalnej długości.

| | |
|----------------|-----------------------------------|
| Źródło światła | SMD LED |
| Moc | 13,8W/mb (SP) lub 27,6W/mb (DP) |
| Strumień | 1930lm/mb (SP) lub 3860lm/mb (DP) |
| Barwa światła | 3000K, 4000K |
| Kąt świecenia | 100° |



Do tych lamp montujemy również systemy ściemniania: Switch Dim, DALI, CASAMBI.

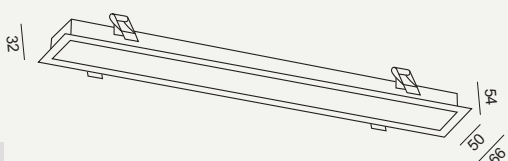

ELKIM
lighting



POINT 880 i 880A



| | |
|----------------|-----------------------|
| Źródło światła | Power LED |
| Moc | 1W |
| Strumień | 94lm - 130lm |
| Barwa światła | 3000K, 4000K, 6000K |
| Kąt świecenia | 880A (30°), 880 (80°) |



Lampa z rozproszoną wiązką światła o kącie 80°

POINT 880

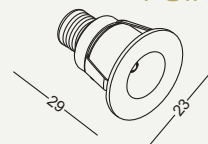

Lampa ze skupioną wiązką światła o kącie 30°

POINT 880A

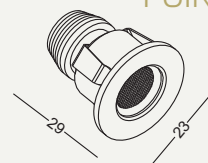

LESEL 001 i 002

| | |
|----------------|---------------------|
| Źródło światła | Power LED |
| Moc | 1W |
| Strumień | 94lm - 130lm |
| Barwa światła | 3000K, 4000K, 6000K |
| Kąt świecenia | 60° |

LESEL 001 występuje w dwóch rozmiarach: L i XL.
Wersja LESEL 001 XL dostępna jest również z czujnikiem ruchu.
LESEL 002 to okrągła wersja LESEL 001 L.

LESEL 001 L

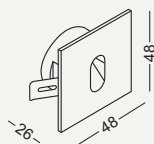

LESEL 002

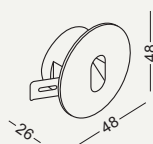

LESEL 001 XL

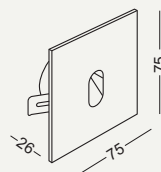

PUSZKA
do wersji L

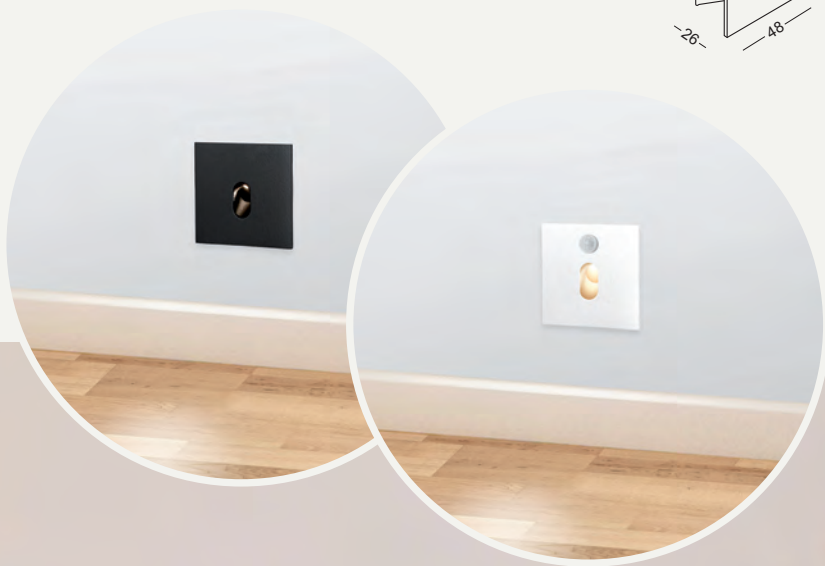
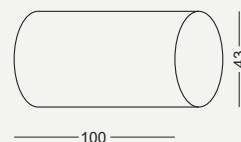

LESEL 008A i 009A

LESEL 008A i 009A występują w dwóch rozmiarach: L i XL.

| | |
|----------------|---------------------|
| Źródło światła | Power LED |
| Moc | 1W |
| Strumień | 94lm - 130lm |
| Barwa światła | 3000K, 4000K, 6000K |
| Kąt świecenia | 360° |

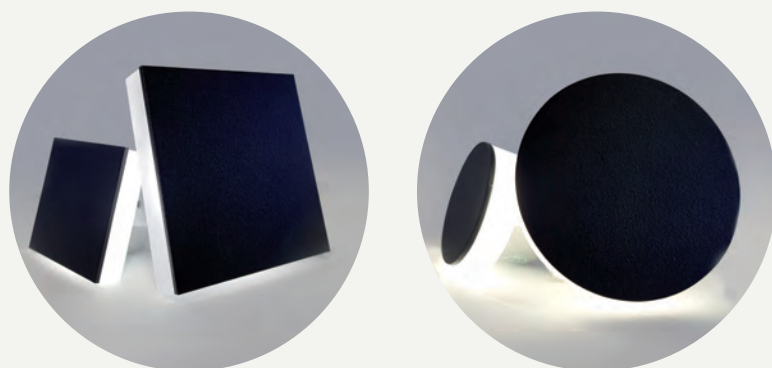

LESEL
008A L

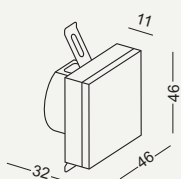

LESEL
008A XL

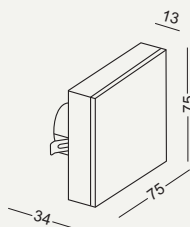

LESEL
009A L

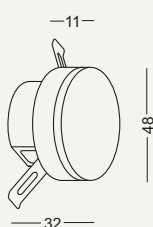

LESEL
009A XL

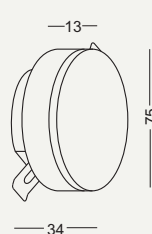

PUSZKA
do wersji L

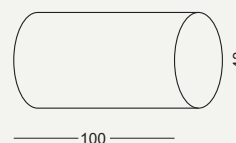

SUN 931

Modele różnią się między sobą mocą i rozmiarem.

| | |
|----------------|-----------------------------------|
| Źródło światła | SMD LED |
| Moc | 6W (M), 10W (L), 20W (XL) |
| Strumień | 420lm (M), 630lm (L), 1400lm (XL) |
| Barwa światła | 3000K |
| Kąt świecenia | 110° |



Lampa SUN występuje w trzech rozmiarach: M, L i XL.

SUN 931 M

SUN 931 L

SUN 931 XL

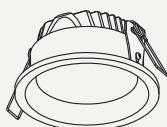

105

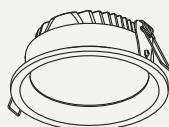

128

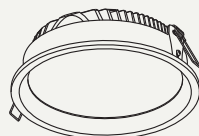

175

59



ELKIM
lighting

PIETRA

sufitowa i zwieszana



| | |
|----------------|--------------|
| Źródło światła | SMD LED |
| Moc | 36W/mb |
| Strumień | 3920lm/mb |
| Barwa światła | 3000K, 4000K |
| Kąt świecenia | 100° |



Lampy sufitowe i zwieszane PIETRA wykonujemy w oparciu o profile długości do L-2000 mm. Lampy sufitowe w części osłonięte są maskownicą.

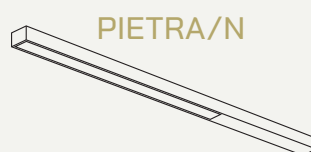

PIETRA/N

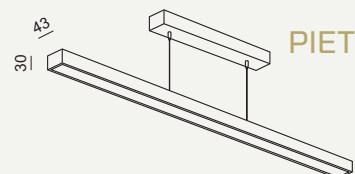

PIETRA/Z

LUPO 180

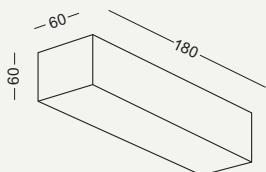

| | |
|----------------|--------------|
| Źródło światła | SMD LED |
| Moc | 2x3W |
| Strumień | 2x300lm |
| Barwa światła | 3000K, 4000K |
| Kąt świecenia | 100° |



ELKIM
lighting

RETI/N 104



| | |
|----------------|-----------------------------------|
| Źródło światła | SMD LED |
| Moc | 4,5W (M), 10W (L), 20W (XL) |
| Strumień | 360lm (M), 800lm (L), 1600lm (XL) |
| Barwa światła | 3000K |
| Kąt świecenia | 110° |

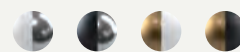

Model M i L jest dostępny tylko ze srebrnym ringiem.

Model XL jest dostępny ze złotym lub srebrnym ringiem.

RETI/N 104 M

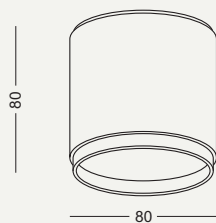

RETI/N 104 L

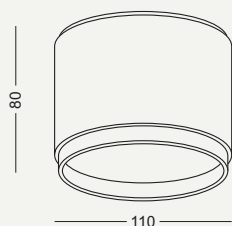

RETI/N 104 XL

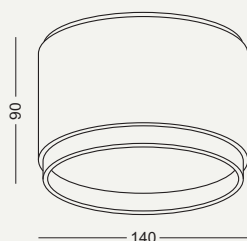

LUPINUS

sufitowy i ścienny

Lampy sufitowe i ścienne LUPINUS wykonujemy w oparciu o profile długości L-3000 mm, dlatego taki profil poprzez jego łączenie ma nieograniczone możliwości pod względem maksymalnej długości. Standardowo montowana jest przesełona SOFT OPAL (w opcji: OPAL lub mikropryzma). Do tych lamp opcjonalnie stosujemy systemy ściemniania: Switch Dim, DALI, CASAMBI.

| | |
|----------------|-----------------------------------|
| Źródło światła | SMD LED |
| Moc | 13,8W/mb (SP) lub 27,6W/mb (DP) |
| Strumień | 1610lm/mb (SP) lub 3900lm/mb (DP) |
| Barwa światła | 3000K, 4000K |
| Kąt świecenia | 90° (HQ), 100° (SQ) |

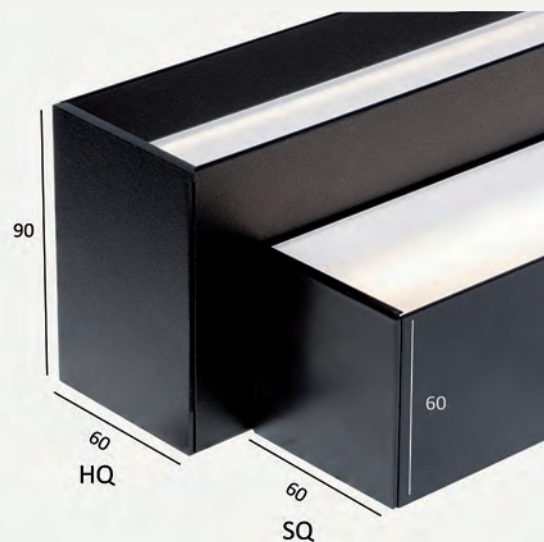

Przykładowe warianty:

Kinkiet z dystansem
świecący góra - dół

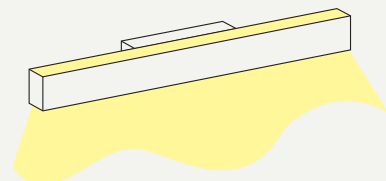

Lampa sufitowa - kształt "L"

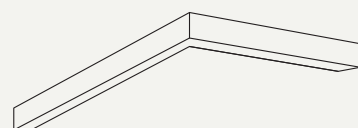

Lampa sufitowa
lub kinkiet bez dystansu



Kinkiet z dystansem

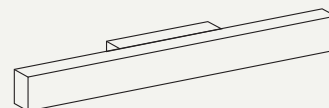

ELKIM
lighting

* więcej na:
www.elkimlighting.pl



Seria lamp BRAKET to lampy sufitowe, wiszące i ścienne.

| | |
|----------------|---------|
| Źródło światła | SMD LED |
| Moc | 6W |
| Strumień | 480lm |
| Barwa światła | 3000K |
| Kąt świecenia | 120° |



BRAKET/K

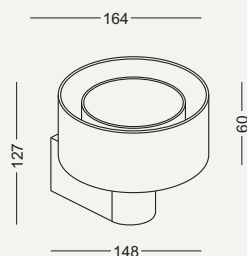

BRAKET/N

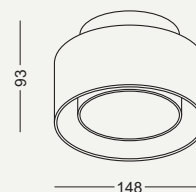

BRAKET/Z

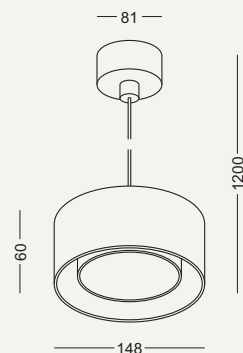

STALA 010



Reflektor szynowy STALA jest w podstawowej wersji na szynę 1F. Wersja z adapterem 3F dostępna jest na zamówienie.

| | |
|----------------|---------------------------|
| Źródło światła | QPAR16 230V GU10 |
| Moc | max 50W |
| Strumień | zależny od źródła światła |
| Barwa światła | zależna od źródła światła |
| Kąt świecenia | zależny od źródła światła |



STALA/T

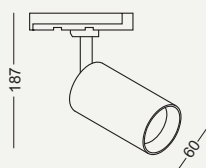

STALA/S

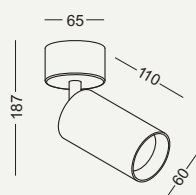

ELKIM
lighting

STALA/Z 010 XL

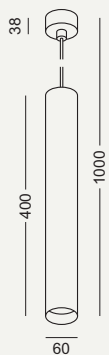

STALA/Z 010 L

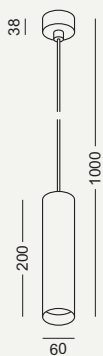

STALA/Z 010 M



Lampy sufitowe i wiszące STALA to oprawy w trzech rozmiarach i w trzech kolorach. Lampy mogą być montowane na zbiorczej podstawie.

| | |
|----------------|---------------------------|
| Źródło światła | QPAR16 230V GU10 |
| Moc | max 50W |
| Strumień | zależny od źródła światła |
| Barwa światła | zależna od źródła światła |
| Kąt świecenia | zależny od źródła światła |

STALA/N 010 XL



STALA/N 010 L



STALA/N 010 M



GRUND 001, 020, 024

GRUND 001

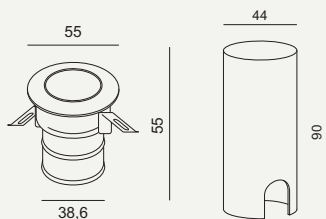

GRUND 024

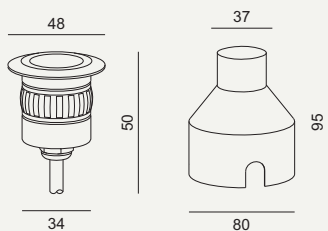

GRUND 020

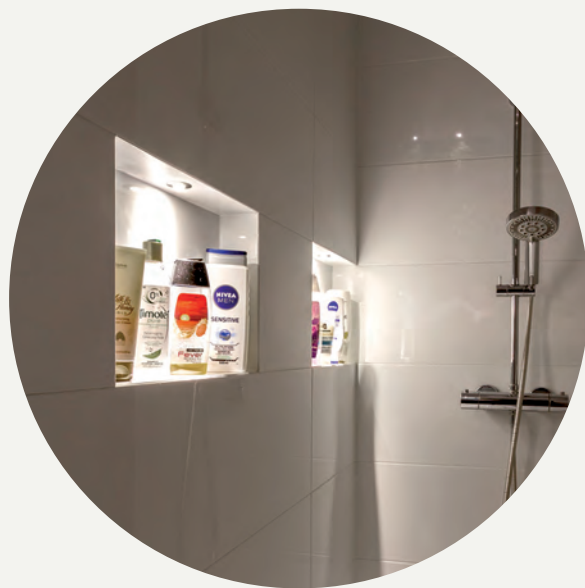
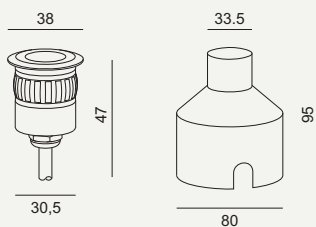

GRUND 001
GRUND 024 GRUND 020

| | | |
|----------------|---------------------|--------------|
| Źródło światła | Power LED | |
| Moc | 3W | 1W |
| Strumień | 160lm - 221lm | 94lm - 130lm |
| Barwa światła | 3000K, 4000K, 6000K | |
| Kąt świecenia | 30°, 60° | |

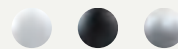

ELKIM
lighting

LEJA 183

| | |
|----------------|-----------------------|
| Źródło światła | LED COB |
| Moc | 5W (L), 12W (XL) |
| Strumień | 460lm (L), 900lm (XL) |
| Barwa światła | 3000K, 4000K |
| Kąt świecenia | 38° |

Lampa hermetyczna LEJA 183 występuje w dwóch rozmiarach: L i XL.



LEJA 183 XL

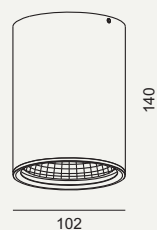

LEJA 183 L

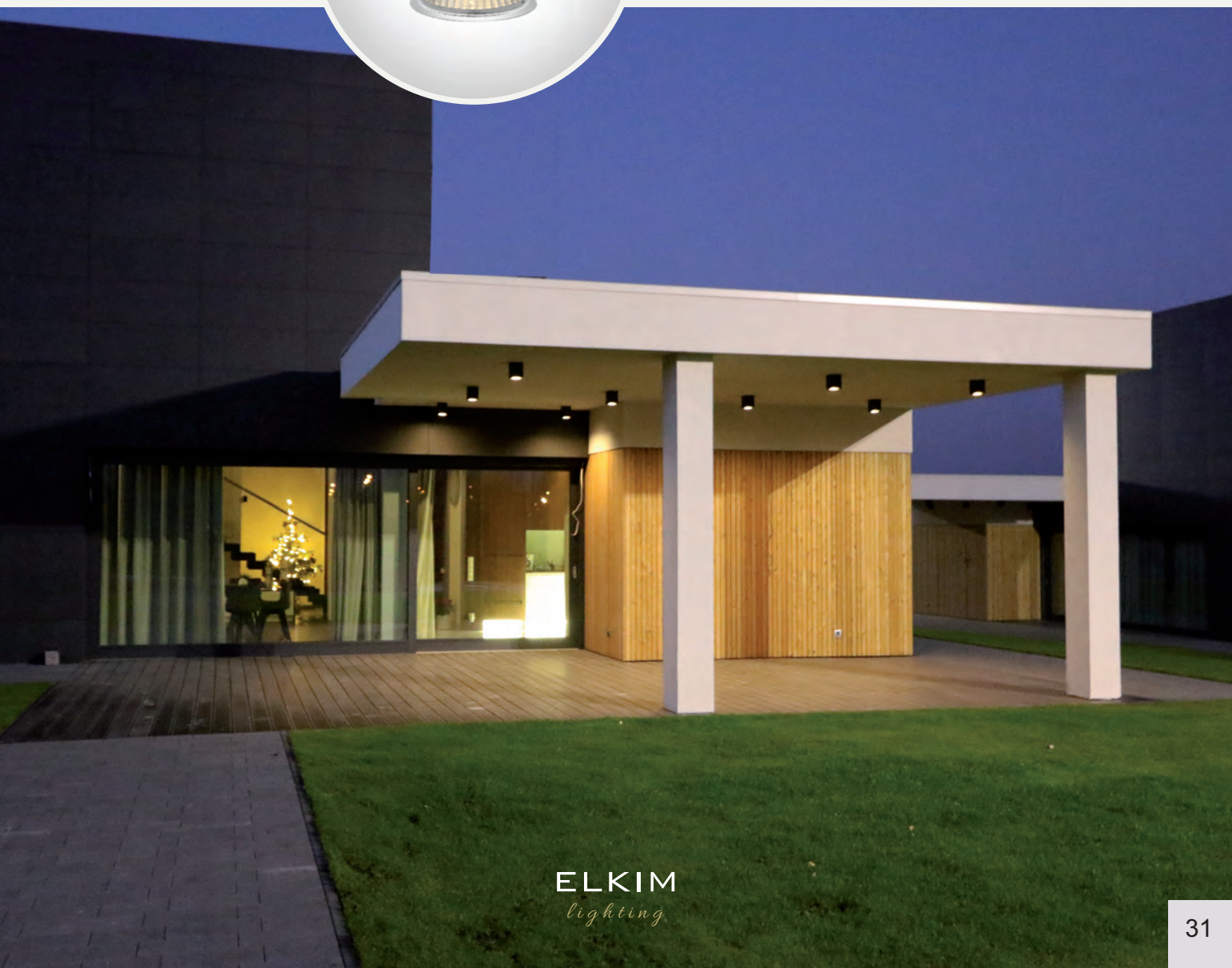

Pozostałe produkty z naszej oferty:



LESEL 004



LESEL 008



LESEL 009



LESEL 008B



LESEL 009B



LESEL 014



POINT 001



POINT 005



RONDO 345



LADIK 390



RUND 007



HAMAL 031/1



HAMAL 031/2



NORIP 149



LIRIO 128/1



LIRIO 128/2



BELL/Z 210



TOBA 173



HADAR 142A



PLUTO 228



TALOR 221



KENT 330



WILA 321



WILA 260



WILA 259



SULTA 232A



WILA 230A



KERIA 219



HOTELS 420



HOTELS 420H



GRUND 028



LESEL 041



LESEL 043



WALLY



QUATRO 300

Więcej na stronie:

www.elkimlighting.pl